



## SH 8390 EN

Translation of original instructions



**Type 3738-20 Electronic Limit Switch**  
with optional integrated solenoid valve for on/off valves



The mounting and operating instructions for the devices are included in the scope of delivery. The latest documentation is available on our website ([www.samsongroup.com](http://www.samsongroup.com)) > Product documentation. You can enter the document number or type number in the [Find:] field to look for a document.

## Definition of signal words

### **DANGER**

*Hazardous situations which, if not avoided, will result in death or serious injury*

### **WARNING**

*Hazardous situations which, if not avoided, could result in death or serious injury*

### **NOTICE**

*Property damage message or malfunction*

### **Note**

*Additional information*

### **Tip**

*Recommended action*

## Purpose of this manual

The Safety Manual SH 8390 contains information relevant for the use of the Type 3738-20 Electronic Limit Switch in safety-instrumented systems according to IEC 61508 and IEC 61511. The safety manual is intended for planners, constructors and operators of safety-instrumented systems.

---

### NOTICE

*Risk of malfunction due to incorrect mounting, connection or start-up of the device. Refer to Mounting and Operating Instructions EB 8390 for details on how to mount the device, perform the electric and pneumatic connections as well as start up the device. Observe the warnings and safety instructions written in the Mounting and Operating Instructions EB 8390.*

---

## Further documentation

The documents listed below contain descriptions of the start-up, functioning and operation of the limit switch. You can download these documents from the SAMSON website.

### Type 3738-20 Electronic Limit Switch

- ▶ T 8390: Data sheet
- ▶ EB 8390: Mounting and operating instructions

### Note

*In addition to the limit switch documentation, observe the technical documentation for the pneumatic actuator, control valve and other valve accessories.*

---

## Contents

<b>1</b>	<b>Scope .....</b>	<b>5</b>
1.1	General .....	5
1.2	Use in safety-instrumented systems .....	5
1.3	Versions and ordering data .....	6
1.4	Mounting .....	6
<b>2</b>	<b>Technical data (excerpt from EB 8390).....</b>	<b>6</b>
<b>3</b>	<b>Safety-related functions .....</b>	<b>8</b>
3.1	Fail-safe action .....	10
<b>4</b>	<b>Mounting, connection and start-up.....</b>	<b>10</b>
<b>5</b>	<b>Required conditions .....</b>	<b>11</b>
5.1	Selection .....	11
5.2	Mechanical and pneumatic installation .....	12
5.3	Electrical installation.....	13
5.4	Operation .....	13
<b>6</b>	<b>Proof testing.....</b>	<b>14</b>
6.1	Function testing .....	15
6.2	Visual inspection to avoid systematic failure .....	18
<b>7</b>	<b>Repairs .....</b>	<b>18</b>
<b>8</b>	<b>Safety-related data and certificates .....</b>	<b>19</b>
8.1	Safety-related data for safety-related monitoring of the fail-safe position .....	19
8.2	Safety-related data for emergency venting by the 'solenoid valve' option.....	20

# 1 Scope

## 1.1 General

The Type 3738-20 Electronic Limit Switch supplies a signal when the valve travel exceeds or falls below an adjusted limit value. The electronic limit switch is designed for attachment to (single- and double-acting) pneumatic actuators. The angle of rotation is measured without contact using a magnet (on a screw) positioned centrally on the actuator shaft.

## 1.2 Use in safety-instrumented systems

Observing the requirements of IEC 61508, the systematic capability of the limit contacts for safety-related monitoring of the fail-safe position of the actuator as components in safety-instrumented systems is given.

Use of the limit switch is possible on observing the requirements of IEC 61511 and the required hardware fault tolerance in safety-instrumented systems up to SIL 2.

The safety-instrumented function for safety-related monitoring of the fail-safe position is to be regarded as a Type B element in accordance with IEC 61508-2.

Use of the Type 3738-20xxx14xxxxx2xx Electronic Limit Switch with integrated solenoid valve is possible on observing the requirements of IEC 61511 and the required hardware fault tolerance in safety-instrumented systems up to SIL 2 (single device/HFT = 0) and SIL 3 (redundant configuration/HFT = 1).

The function of Type 3738-20xxx14xxxxx2xx for emergency shutdown is to be regarded as a Type A element in accordance with IEC 61508-2.

---

**i Note**

*The architecture and the interval between proof tests must be changed accordingly for a higher safety integrity level.*

---

### 1.3 Versions and ordering data

All versions of the Type 3738-20 Electronic Limit Switch are suitable for use in safety-instrumented systems. Versions with integrated solenoid valve or for attachment of an external solenoid valve are available.

The article code indicates whether the version has an integrated solenoid valve or an external solenoid valve.

Electronic Limit Switch	Type 3738-20	x	x	1	x	0	0	x	x	x	2	0	x
Solenoid valve													
External						0							
Integrated							4						

### 1.4 Mounting

The electronic limit switch is suitable for the following types of attachment in combination with various mounting parts:

- Attachment to linear actuators according to IEC 60534-6 (NAMUR)
- Attachment to rotary actuators acc. to VDI/VDE 3845, fixing level 1

## 2 Technical data (excerpt from EB 8390)

Electronic Limit Switch Type	3738-20xxx14xxxxx2xx	3738-20xxx1000xxx200
Version	With integrated solenoid valve	For external solenoid valve
Permissible range of rotation	Min.: 0 to 30° Max.: 0 to 170°	
Supply air	2.4 to 8 bar	Same as specifications of the solenoid valve manufacturer
Air quality	According to ISO 8573-1 Max. particle size and density: Class 4 Oil content: Class 3 Moisture and water: Class 3 Pressure dew point: at least 10 K below the lowest ambient temperature to be expected	
Electric power supply	Powered over contact A acc. to DIN EN 60947-5-6 (e.g. NAMUR isolating switch amplifier)	

Electronic Limit Switch Type		3738-20xxx14xxxxx2xx	3738-20xxx1000xxx200
Version		With integrated solenoid valve	For external solenoid valve
Permissible ambient temperature The temperature limits for the explosion-protected devices may be restricted by the limits specified in the test certificates.		-25 to 80 °C  The permissible operating temperature for use in safety-instrumented systems is -25 to 70 °C  Metal cable glands must be used for ambient temperatures below -20 °C.	-40 to 80 °C
Influences	Temperature	±0.7 %/90° angle above the permissible temperature range	
	Effect of vibration	≤0.25 % up to 2500 Hz and 4 g according to IEC 770	
Electromagnetic compatibility		Complying with EN 61000-6-2, EN 61000-6-3, EN 61326-1 and NAMUR Recommendation NE 21	
Degree of protection		IP 66	
Safety approval	Safety-related end position monitoring	The limit switches are suitable for use in safety-instrumented systems up to SIL 2 (single channel) and SIL 3 (redundant configuration) according to IEC 61508. For further details, see section 3.	
	Emergency venting	See section 3	Same as specifications of the solenoid valve manufacturer
Switching function		NC contact	NO contact
Switching contacts	No response/no fault	≥2.2 mA	≤1.0 mA
	Response/fault indication	≤1.0 mA	≥2.2 mA
Hysteresis		1 %	
Contacts	Contact A Limit contact for fail-safe position (solenoid valve de-energized)	<b>PTO (power to open):</b> responds when the valve moves through the switching contact towards the lower end position (P7) <b>PTO (power to open):</b> responds when the valve moves through the switching contact towards the lower end position (P8)	
	Contact B Limit contact for operating position (solenoid valve energized)	<b>PTO (power to open):</b> responds when the valve moves through the switching contact towards the lower end position (P8) <b>PTO (power to open):</b> responds when the valve moves through the switching contact towards the lower end position (P7) Signal for wire breakage according to DIN EN 60947-5-6	

## Safety-related functions

Integrated solenoid valve in Type 3738-20xxx14xxxxx2xx Electronic Limit Switch		
Current draw	$I = \frac{2,7 \text{ U}}{3650 \Omega} - 3.325 \text{ mA}$ (corresponding to 14.4 mA at 24 V)	
Version	3/2-way or 5/2-way function Function determined by the position of the molded seal	
K <sub>VS</sub> coefficient	0.32	
Service life	1,000,000 switching cycles	
Temperature range (operation)	-25 to +80 °C	
Switching voltage	Nominal voltage	24 V DC, reverse polarity protection, galvanic isolation
	Signal 0	When the voltage falls below 15 V DC Emergency venting at 0 V
	Signal 1	Min. 18 V DC
Switching capacity	24 V DC; 15.2 mA (0.36 W)	
Duty cycle	100 %	
Static destruction limit	32 V DC	

External solenoid valve for Type 3738-20xxx1000xxx200 Electronic Limit Switch		
Read manufacturer's specifications.		
24 V DC, max. 18 W		
Switching voltage	Signal 0	When the voltage falls below 15 V DC
	Signal 1	Min. 18 V DC
Static destruction limit	32 V DC	

## 3 Safety-related functions

### 1. Safety-related monitoring of the fail-safe position (Fig. 1 path )

The valve position is recorded by the non-contact position sensing using an AMR sensor and directly processed by the microprocessor in the limit switch. The fail-safe position is indicated by the NAMUR contacts (according to IEC 60947-5-6) at terminal A.

### 2. Emergency venting over the optional solenoid valve (Fig. 1 path )

Type 3738-20xxx14xxxxx2xx only

The optionally integrated solenoid valve (7) is energized by a 24 V DC voltage signal. When there is no signal (0 V DC) at terminal V1 or V3, the fail-safe action is triggered and the solenoid valve (7) vents the actuator.



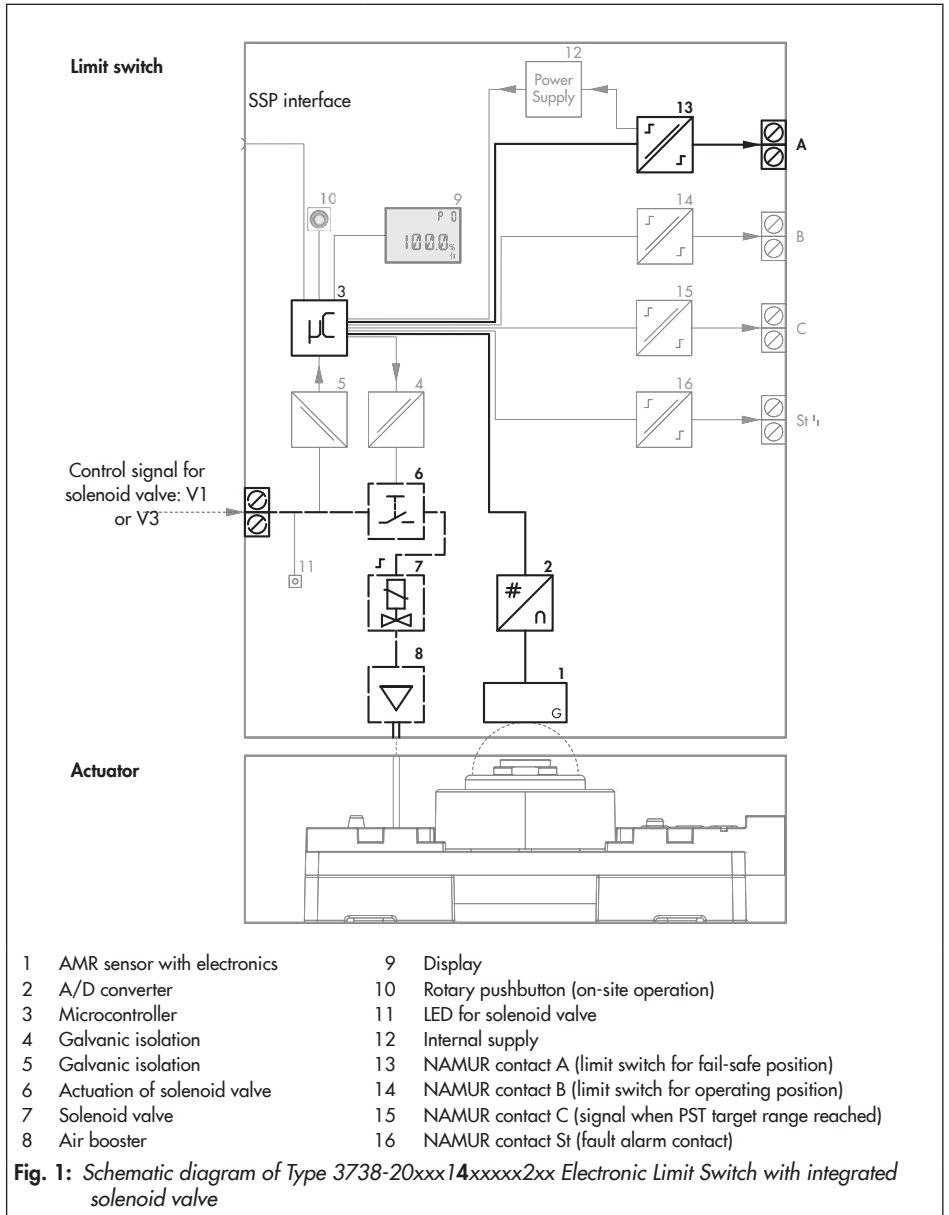

### 3.1 Fail-safe action

Fail-safe action is triggered by the integrated or external solenoid valve and upon supply air failure. The limit switch fully discharges its pneumatic output to the atmosphere, causing the pneumatic actuator to be vented. As a result, the valve moves to the fail-safe position. The fail-safe position depends on how the springs are arranged in the pneumatic actuator (air-to-close or air-to-open). The fail-safe position is indicated by the NAMUR contact A and issued as a NAMUR signal.

When the air supply fails and the optional integrated solenoid valve is de-energized, all other device functions, (including diagnostics, discrete position and status feedback) remain active.

#### Protection against unauthorized changes to the configuration

A change to the configuration cannot affect the safety function nor cause it to be deactivated.

## 4 Mounting, connection and start-up

Refer to Mounting and Operating Instructions ► EB 8390 for details on how to mount, perform the electric and pneumatic connections as well as start up the limit switch.

Only use the specified original mounting parts and accessories.

#### Electrical connections:

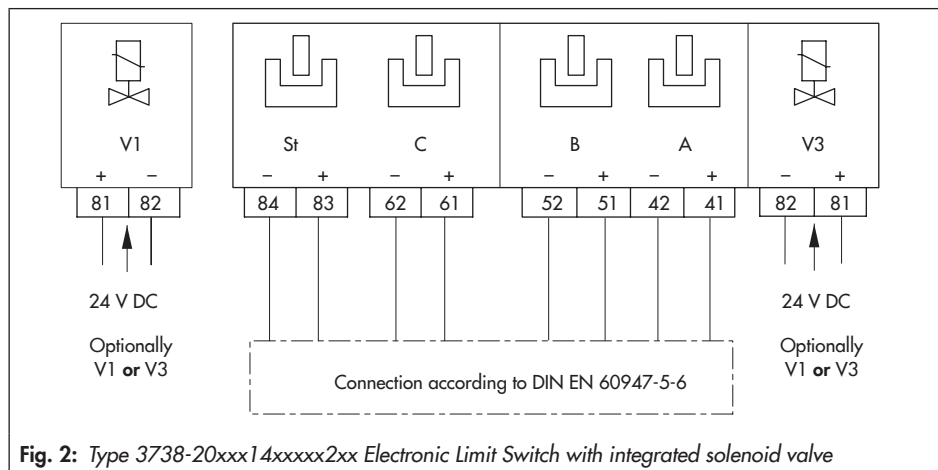

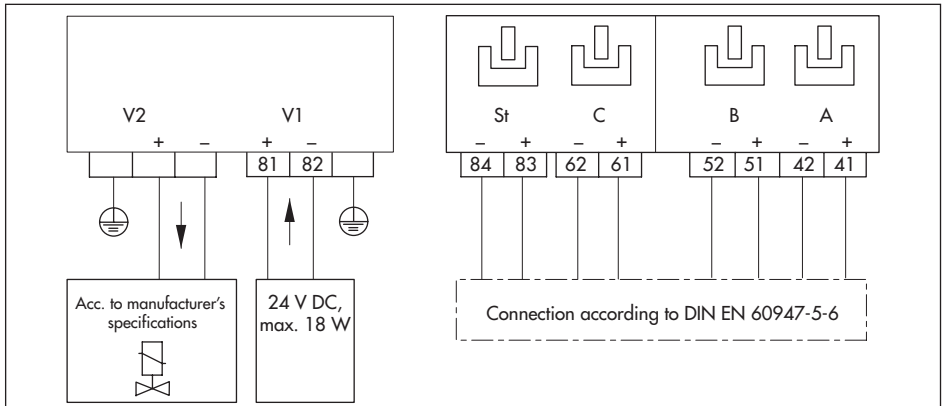

Fig. 3: Type 3738-20xxx1000xxx200 Electronic Limit Switch with external solenoid valve

## 5 Required conditions

### **⚠ WARNING**

Risk of malfunction due to incorrect selection or wrong installation and operating conditions. Only use control valves in safety-instrumented systems if the necessary conditions in the plant are fulfilled. The same applies to the mounted limit switch.

### 5.1 Selection

- The required transit time of the control valve in case of emergency is observed. The transit time to be implemented is determined by the process engineering requirements.

#### **💡 Tip**

The P13 parameter can be used to monitor the actuator transit time. The F4 status is issued when the actuator transit time entered is exceeded after the solenoid valve is de-energized. The exact actuator transit time can be read in P22 parameter after the electronic limit switch has been initialized.

## Required conditions

→ The limit switch is suitable for the prevailing ambient temperature.

Electronic Limit Switch Type	3738-20xxx14xxxxx2xx	3738-20xxx1000xxx200
Implementation	With integrated solenoid valve	For external solenoid valve
Permissible ambient temperature The temperature limits for the explosion-protected devices may be restricted by the limits specified in the test certificates.	-25 to 80 °C  The permissible operating temperature for use in safety-instrumented systems is -25 to 70 °C  Metal cable glands must be used for ambient temperatures below -20 °C.	-40 to 80 °C

## 5.2 Mechanical and pneumatic installation

→ The limit switch is mounted properly as described in the mounting and operating instructions and connected to the air supply.

→ The supply pressure does not exceed the maximum limit.

Electronic Limit Switch Type	3738-20xxx14xxxxx2xx	3738-20xxx1000xxx200
Implementation	With integrated solenoid valve	For external solenoid valve
Supply air	2.4 to 8 bar	Same as specifications of the solenoid valve manufacturer

→ The pneumatic air supply meets the instrument air specifications.

Electronic Limit Switch Type	3738-20xxx14xxxxx2xx	3738-20xxx1000xxx200
Implementation	With integrated solenoid valve	For external solenoid valve
Particle size and quantity	Class 4 ≤ 5 µm and 1000/m <sup>3</sup>	Same as specifications of the solenoid valve manufacturer
Oil content	Class 3 ≤ 1 mg/m <sup>3</sup>	
Pressure dew point	Class 3 -20 °C or at least 10 K below the lowest ambient temperature to be expected	



### Tip

We recommend installing a supply pressure regulator/filter upstream of the device. For example, the SAMSON Type 4708 Supply Pressure Regulator with 5 µm filter cartridge can be used.

- Operation using a pressure reducing valve: The  $K_{VS}$  coefficient of a pressure reducing valve must be at least 1.6 times larger than the  $K_{VS}$  coefficient of the solenoid valve.
- The supply air line has a minimum inside diameter of 4 mm.  
Select the cross section and length of the line to ensure that the supply pressure at the device on supplying air does not fall below the minimum limit.
- Protect the exhaust air connections and vent plugs to prevent water or dirt from entering them.

### 5.3 Electrical installation

- The electronic limit switch is connected to the electric power supply properly as described in the mounting and operating instructions.
- Only cables whose outside diameters are suitable for the cable glands are used.
- The electrical cables in Ex i circuits comply with the data that planning was based on.
- The cable glands and cover screws are fastened tightly to ensure that the degree of protection is met.
- The installation requirements for the applicable explosion protection measures are observed.
- The special conditions specified in the explosion protection certificates are observed.

### 5.4 Operation

- The fail-safe position at NAMUR contact A corresponds with the required fail-safe position of the application.

---

#### **i** Note

*The fail-safe position is the end position to which the single-acting actuator is moved by the spring-return mechanism when the solenoid valve is de-energized. It can be adjusted at the Type 3738 Electronic Limit Switch at the parameters P5 to P8:*

- P5: Direction of action of the actuator (PTO (power to open)/PTC (power to close))
  - P6: Switching function of NAMUR contacts A, B, C
  - P7: Switching contact, fail-safe position with direction of action PTO
  - P8: Switching contact, fail-safe position with direction of action PTC
-

## Proof testing

- There is no critical error E9 at the electronic limit switch.  
Diagnostics are performed cyclically inside the device. Critical errors (device error E9) are indicated by contact B as wire breakage according to DIN EN 60947-5-6. Existing errors must be remedied as described in Mounting and Operating Instructions
- ▶ EB 8390. If this is not possible, the electronic limit switch must not be used in safety loops.



### Tip

After each start-up of the device, we recommend testing the display functions using the P3 parameter and contact functions using P19 parameter (▶ EB 8390).

---

## 6 Proof testing

The proof test interval and the extent of testing lie within the operator's responsibility. The operator must draw up a test plan, in which the proof tests and the interval between them are specified. We recommend summarizing the requirements of the proof test in a checklist.

---

### WARNING

**Risk of dangerous failure due to malfunction in the event of emergency.**

**Malfunction in the case of emergency include:**

- The fail-safe position is not indicated at terminal A.
  - Type 3738-20xxx14xxxxx2xx only: actuator does not vent and/or the valve does not move to the fail-safe position.
- Only use devices in safety-instrumented systems that have passed the proof test according to the test plan drawn up by the operator.
- 

Regularly check the safety-instrumented function of the entire SIS loop. The test intervals are determined, for example on calculating each single SIS loop in a plant ( $PFD_{avg}$ ).

## 6.1 Function testing

Regularly check the safety function according to the test plan drawn up by the operator.

### **i** Note

Record any faults in the electronic limit switch and inform SAMSON of them in writing.

#### – Safety-related end position monitoring:

1. Verify reading on display. To do this, check that all the selected display readings 1 to 10 are the same as shown as follows:

Turn  → P3

Press , reading 1

Turn  → Reading 2 to 10

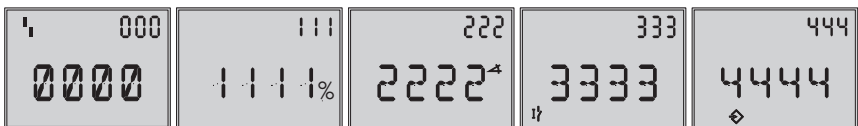

Display reading 1   Display reading 2   Display reading 3   Display reading 4   Display reading 5

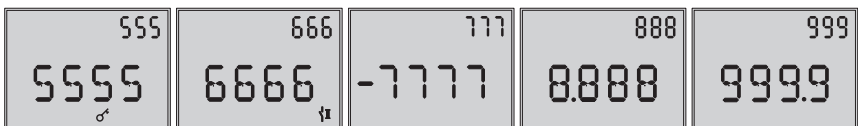

Display reading 6   Display reading 7   Display reading 8   Display reading 9   Display reading 10

2. Check that the E9 or E10 device error does not exist.  
When an error message is generated, the  fault icon is displayed. The possible cause of the fault is indicated by the ERR parameter reading. In this case, E9 and E10 should not be listed.
3. Test input of required switching function at P6 parameter.
4. Test switching point of the limit contacts in P7 and P8 parameters.

Turn  → P7

Switching contact, lower end position;

fail-safe position with direction of action PTO (power to open),

operating position with direction of action PTC (power to close)

## Proof testing

Turn  → **P8**

Switching contact, upper end position;  
operating position with direction of action PTO (power to open),  
fail-safe position with direction of action PTC (power to close)

5. De-energize the solenoid valve and perform a visual check. The valve must be in the fail-safe position.
6. Test position in P0 parameter. The parameter must indicate 0 % or 100 % depending how P6 to P8 are configured.
7. Check switching state of limit contact A in the fail-safe position.
8. Move valve to the operating position using the solenoid valve.
9. Test position in P0 parameter. The parameter must indicate 0 % at 100 % fail-safe position or 100 % at 0 % fail-safe position.
10. Check switching state of limit contact B in the operating position.

### – Emergency venting over the optional solenoid valve

Type 3738-20xxx14xxxxx2xx only

1. Verify reading on display. To do this, check that all the selected display readings 1 to 10 are the same as shown as follows:

Turn  → **P3**

Press , reading 1

Turn  → Reading 2 to 10

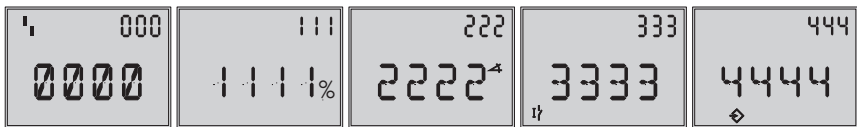

Display reading 1

Display reading 2

Display reading 3

Display reading 4

Display reading 5



Display reading 6















Display reading 7

Display reading 8

Display reading 9

Display reading 10



2. Check that the E9 or E10 device error does not exist.  
When an error message is generated, the  fault icon is displayed. The possible cause of the fault is indicated by the ERR parameter reading. In this case, E9 and E10 should not be listed.
3. Select SET operating mode.  
Turn  → **P2**  
Press   
Turn  → Key number  
Press . The SET operating mode is set.
4. Activate the switching voltage of the solenoid valve.
5. Test the solenoid valve.  
The valve position must correspond with the indicated operating position in normal operation.  
When the solenoid valve is de-energized, the valve must move to the fail-safe position.  
Turn  → **P20**  
Press   
Turn  → Operating position (0 or 100 %, depending on the configuration of P6 to P8)  
Turn  to de-energize the solenoid valve (the valve moves to the fail-safe position; 0 or 100 %, depending on the configuration of P6 to P8) while the rotary pushbutton is pressed.  
Turn  → **ESC**  
Press  to exit the parameter.
6. Select RUN operating mode.  
Turn  → **P2**  
Press   
Turn  → Key number  
Press . The RUN operating mode is set.

### 6.2 Visual inspection to avoid systematic failure

To avoid systematic failure, inspect the electronic limit switch regularly. The frequency and the scope of the inspection lie within the operator's responsibility. Take application-specific influences into account, such as:

- Dirt blocking the pneumatic connections
- Corrosion (destruction primarily of metals due to chemical and physical processes)
- Material fatigue
- Aging (damage caused to organic materials, e.g. plastics or elastomers, by exposure to light and heat)
- Chemical attack (organic materials, e.g. plastics or elastomer, which swell, leach out or decompose due to exposure to chemicals)

---

#### **NOTICE**

*Risk of malfunction due to the use of unauthorized parts.  
Only use original parts to replace worn parts.*

---

## 7 Repairs

Only perform the work on the electronic limit switch described in ► EB 8390.

---

#### **NOTICE**

*Safety function impaired due to incorrect repair.  
Only allow trained staff to perform service and repair work.*

---

## 8 Safety-related data and certificates

The Type 3738-20 Electronic Limit Switch is suitable for use in safety-instrumented systems according to IEC 61508 and IEC 61511. It is suitable for use in safety-instrumented systems regarding:

- The switches up to SIL 2 (single device) (see section 8.1)
- The internal solenoid valve up to SIL 2 (single device) and SIL 3 (redundant configuration) according to IEC 61508 (see section 8.2)

The conformity of the development process and the performed FMEDA have been certified by TÜV Rheinland Industrie Service GmbH in certificate 968/EL 485.03/15 of 26 March 2015.

**Evidence of the update/review is provided based on the user's previous experience (proven-in-use).**

### 8.1 Safety-related data for safety-related monitoring of the fail-safe position

$\lambda_{\text{safe undetected}}$	452 FIT
$\lambda_{\text{safe detected}}$	0 FIT
$\lambda_{\text{dangerous undetected}}$	62.7 FIT
$\lambda_{\text{dangerous detected}}$	113 FIT
PFD <sub>avg</sub> with annual test	$2.75 \cdot 10^{-04}$
HFT (Hardware Fault Tolerance)	0
DC (Diagnostic Coverage)	64.3 %
Device type	B
Safe failure fraction (SFF)	90 %
MTBF <sub>total</sub>	182 years
MTBF <sub>dangerous, undetected</sub>	1820 years

1 FIT = 1 failure per 10<sup>9</sup> hours

#### Useful lifetime

According to IEC 61508-2, section 7.4.9.5, a useful lifetime of eight to twelve years can be assumed. Other values can be used based on the user's previous experience (prior use).

#### Intended use

→ See Mounting and Operating Instructions ► EB 8390

### Safety-related assumptions

The switching contacts respond as stipulated in IEC 60947-5-6. They are normally closed contacts, i.e. the limit contact assumes high resistance in the end position.

**Definition of fail-safe position:** this is the end position to which the actuator moves after the solenoid valve is de-energized. Limit contact A is assigned to the end position for the fail-safe position. To indicate that a critical condition inside the device has been detected, the output of the limit contact B is set to the output current for a wire break ( $I < 50 \mu\text{A}$ ) and the device's output are moved to the safe state.

## 8.2 Safety-related data for emergency venting by the 'solenoid valve' option

### **i** Note

The following data only apply to the Type 3738-20xxx14xxxxx2xx Electronic Limit Switch.

$\lambda_{\text{safe undetected}}$	171 FIT
$\lambda_{\text{safe detected}}$	0 FIT
$\lambda_{\text{dangerous undetected}}$	57 FIT
$\lambda_{\text{dangerous detected}}$	0 FIT
PFD <sub>avg</sub> with annual test	$2.5 \cdot 10^{-04}$
HFT (Hardware Fault Tolerance)	0
DC (Diagnostic Coverage)	0 %
Device type	A
Safe failure fraction (SFF)	75 %
MTBF <sub>total</sub>	500 years
MTBF <sub>dangerous, undetected</sub>	2002 years

1 FIT = 1 failure per  $10^9$  hours

### Useful lifetime

According to IEC 61508-2, section 7.4.9.5, a useful lifetime of eight to twelve years can be assumed. Other values can be used based on the user's previous experience (prior use).

### Intended use

➔ See Mounting and Operating Instructions ► EB 8390

### Quality requirements for instrument air

- See mounting and operating instructions or operating manual for mounted valve accessories (e.g. positioner, solenoid valve)

### Safety-related assumptions

When the electrical input (V1 and V3) is de-energized, the pneumatic output of the Type 3738-20xxx14xxxxx2xx Electronic Limit Switch is vented to the atmosphere.

### Requirements

- Short mean time to repair compared to the average rate of demand.
- Normal exposure to industrial environment and fluids.
- The user is responsible for ensuring that the device is used as intended.





SH 8390 EN



SAMSON AKTIENGESELLSCHAFT  
Weismüllerstraße 3 · 60314 Frankfurt am Main, Germany  
Phone: +49 69 4009-0 · Fax: +49 69 4009-1507  
samson@samsongroup.com · www.samsongroup.com